

# FS-G4P1-BS&FS-R4D-ESC-BS

USER MANUAL

# FLYSKY

## Digital Proportional Radio Control System

2.4GHz  
2A-BS

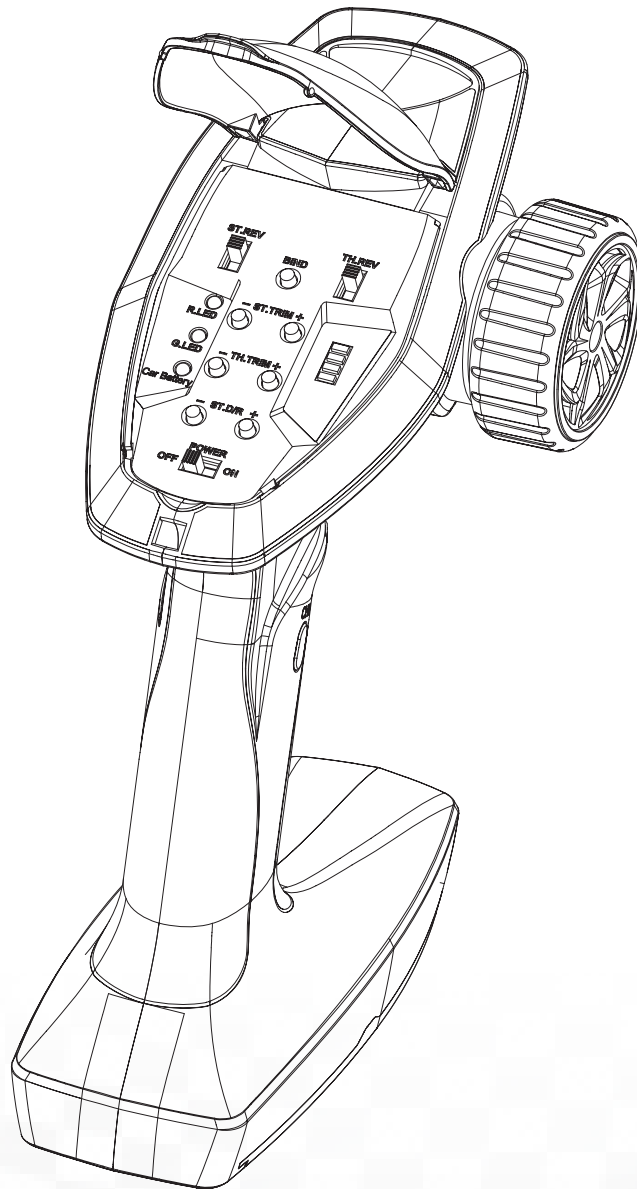

Copyright ©2023 Flysky Technology Co., Ltd.



微信公众号



Bilibili



Website



Facebook



15+



**WARNING:**

This product is only for 15 years old or above



Thank you for purchasing our products. Read the manual carefully to ensure your personal safety as well as the safety of your equipment.

If you encounter any problems during using, please refer to this manual first. If the problem is still not resolved, please contact the local dealer directly or contact the customer service staff via the website below:

<http://www.flysky-cn.com>



# Contents

<b>1. Safety</b> .....	<b>1</b>
1.1 Safety Symbols .....	1
1.2 Safety Guide .....	1
<b>Mandatory</b> .....	<b>1</b>
<b>2. Introduction</b> .....	<b>2</b>
2.1 Transmitter Overview .....	2
2.2 Receiver Overview .....	4
<b>3. Getting Started</b> .....	<b>5</b>
3.1 Transmitter Battery Installation.....	5
3.2 Receiver and Servo Installation .....	5
<b>4. Instructions</b> .....	<b>6</b>
4.1 Power On.....	6
4.2 LED Indicator.....	6
4.3 Binding .....	6
4.4 Stick Calibration .....	7
4.5 Power Off .....	7
<b>5. System Functions</b> .....	<b>8</b>
5.1 Channel Descriptions .....	8
5.2 Channel Reverse .....	8
5.3 Trims.....	8
5.4 D/R.....	9
5.5 Mode Switching .....	9
5.6 Failsafe .....	9
5.7 Beginner Mode .....	10
5.8 ESC Parameters Settings .....	10
5.9 Reset Data .....	11
<b>6. FS-R4D-ESC-BS Function Instructions</b> .....	<b>12</b>
6.1 Attentions .....	12
6.2 Binding Instruction .....	12
6.3 Protect Function .....	12
6.4 Car Light Control .....	13
6.5 ESC Function Instructions .....	15
6.6 ESC Drag Brake Force .....	16
6.7 ESC Running Mode .....	16
6.8 ESC Battery Type .....	16
6.9 Failsafe.....	16
6.10 Troubleshootings .....	17
<b>7. Product Specifications</b> .....	<b>18</b>
7.1 Transmitter Specifications( FS-G4P1-BS) .....	18
7.2 Receiver Specifications (FS-R4D-ESC-BS) .....	19
<b>8. Package Contents</b> .....	<b>20</b>
<b>9. Certifications</b> .....	<b>21</b>
9.1 DoC Declaration .....	21
9.2 CE Warning.....	21
9.3 FCC Statement .....	21
9.4 Environmentally Friendly Disposal.....	22

## 1. Safety

### 1.1 Safety Symbols

Pay close attention to the following symbols and their meanings. Failure to follow these warnings could cause damage, injury or death.

 Danger	• Not following these instructions may lead to serious injuries or death.
 Warning	• Not following these instructions may lead to major injuries.
 Attention	• Not following these instructions may lead to minor injuries.

### 1.2 Safety Guide



Prohibited



Mandatory



- Do not use the product at night or in bad weather like rain or thunderstorm. It can cause erratic operation or loss of control.
- Do not use the product when visibility is limited.
- Do not use the product on rain or snow days. Any exposure to moisture (water or snow) may cause erratic operation or loss of control.
- Interference may cause loss of control. To ensure the safety of you and others, do not operate in the following places:
  - Near any site where other radio control activity may occur
  - Near power lines or communication broadcasting antennas
  - Near people or roads
  - On any body of water when passenger boats are present
- Do not use this product when you are tired, uncomfortable, or under the influence of alcohol or drugs. Doing so may cause serious injury to yourself or others.
- The 2.4GHz radio band is limited to line of sight. Always keep your model in sight as a large object can block the RF signal and lead to loss of control.
- Do not touch any part of the model that may generate heat during operation, or immediately after use. The engine, motor or speed control, may be very hot and can cause serious burns.



- Misuse of this product may lead to serious injury or death. To ensure the safety of you and your equipment, read this manual and follow the instructions.
- Make sure the product is properly installed in your model. Failure to do so may result in serious injury.
- Make sure to disconnect the receiver battery before turning off the transmitter. Failure to do so may lead to unintended operation and cause an accident.
- Ensure that all servos operate in the correct direction. If not, adjust the direction first.
- Make sure the model stays within the systems maximum range to prevent loss of control.



微信公众号



Bilibili



Website



Facebook

## 2.Introduction

The FS-G4P1-BS is a simplified 4-channel transmitter that adopts the 2.4GHz 2A-BS Automatic Frequency Hopping Digital System which is independently developed by the FLYSKY. Its appearance shows speed, passion and power with the elements of sports car. It can set ESC parameters through the transmitter. This transmitter also has a Beginner Mode for entry players to use.

### 2.1 Transmitter Overview

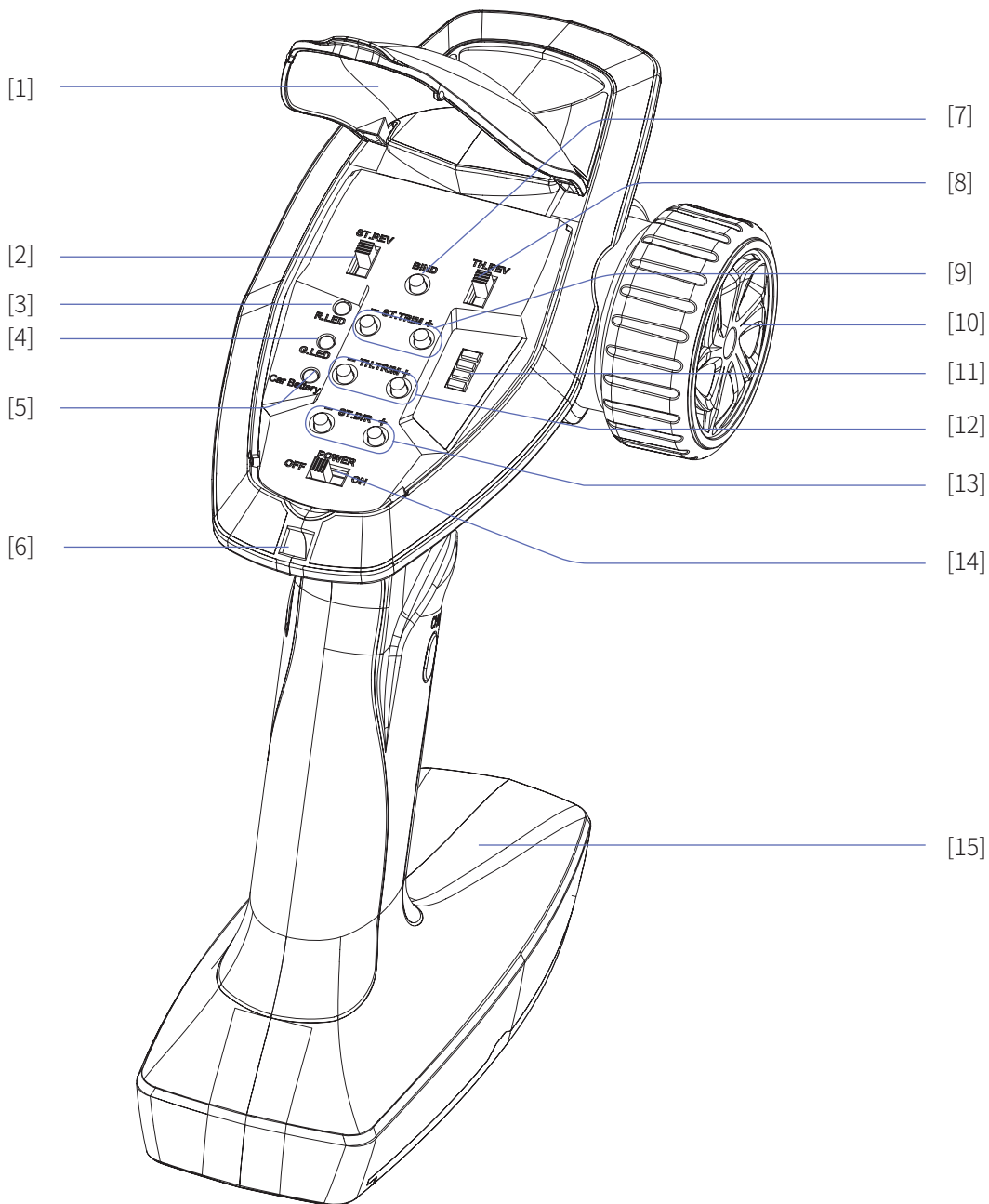

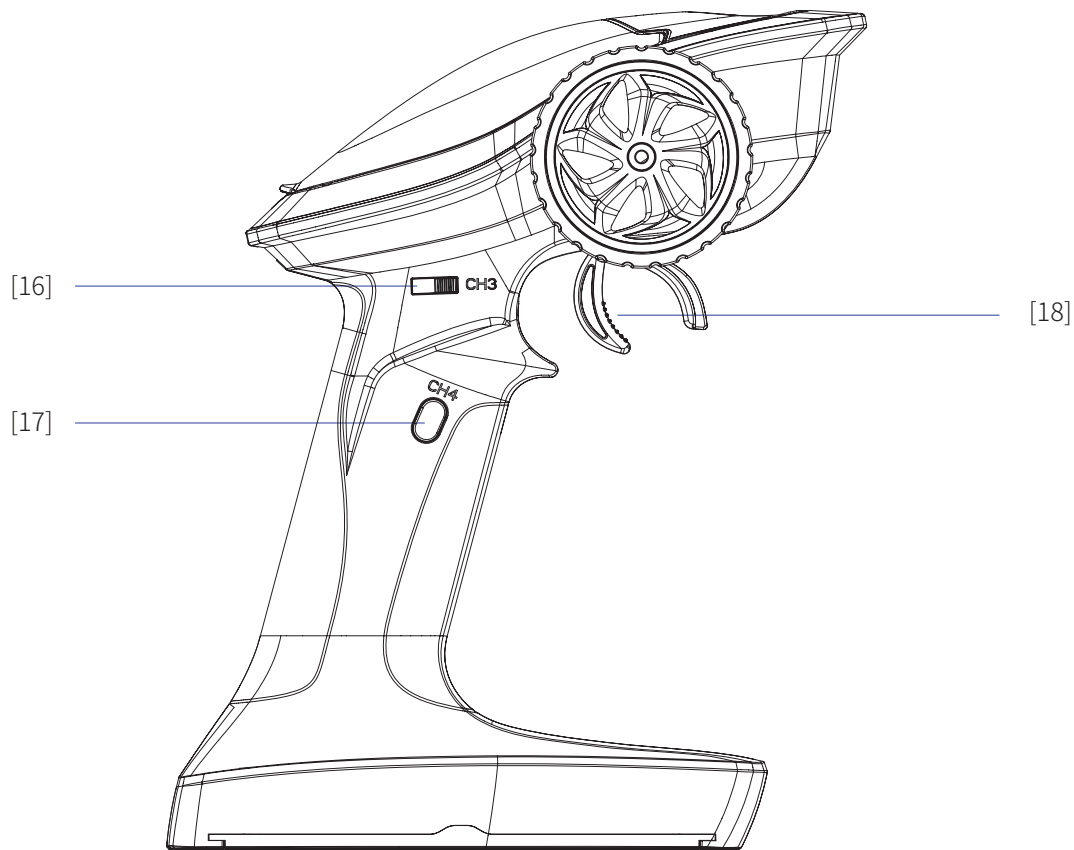

[1] Panel Flip Cover	[10] Steering Wheel Angle, the maximum rotation of the steering wheel is 35 degrees from center to left or right (CH1).
[2] ST.REV, Steering Channel Reverse Button	[11] Toggle Switch, to set the related function of ESC.
[3] R.LED, Power Indicator	[12] TH.TRIM, to adjust the trim of throttle channel.
[4] G.LED, Status Indicator	[13] ST.D/R, to adjust the D/R for steering channel.
[5] Car Battery, ESC Battery Power Indicator	[14] Power Switch
[6] Lanyard Hole	[15] Base, 4 * AA Battery Compartment
[7] Bind Button (BIND)	[16] Three-position Switch (CH3)
[8] TH.REV, Throttle Channel Reverse Button	[17] Button Switch(CH4) [It is a flipping type button.]
[9] ST.TRIM, to adjust the trim of steering channel.	[18] Throttle Trigger, has a total moving angle of 37.5 degrees, 25 degrees forward, and 12.5 degrees backward (CH2).



微信公众号



Bilibili



Website



Facebook

## 2.2 Receiver Overview

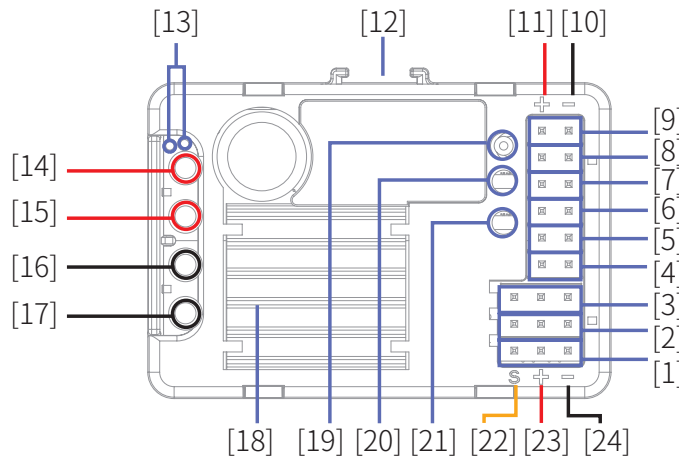

- |                                       |                                      |                               |
|---------------------------------------|--------------------------------------|-------------------------------|
| [1] CH1                               | [9] Roof Light Interface             | [17] - (Motor Cable Cathode)  |
| [2] CH3                               | [10] - (Car Light Interface Cathode) | [18] Heatsink                 |
| [3] CH4                               | [11] + (Car Light Interface Anode)   | [19] Antenna                  |
| [4] Left Turn Signal Light Interface  | [12] Tab for Hanging Power Switch    | [20] Receiver LED             |
| [5] Right Turn Signal Light Interface | [13] Power Switch Cable              | [21] ESC LED                  |
| [6] Headlight Interface               | [14] + (Motor Cable Anode)           | [22] Signal Pin(CH Interface) |
| [7] Tail Light Interface              | [15] + (Power Cable Anode)           | [23] + (CH Interface Anode)   |
| [8] Ambient Light Interface           | [16] - (Power Cable Cathode)         | [24] - (CH Interface Cathode) |

The car light interface is a standard 2.54mm\*2 Pins.

### Receiver Features







1. The integrated design of the ESC and the motor greatly reduces the overall volume and weight, and makes the layout and routing of car frame simpler and more convenient.
2. PPX7 excellent waterproof and dustproof performance make it easily cope a variety of complex environments.
3. The parameters of ESC can be set through the transmitter in real time, no need to connect parameter adjusting equipment or remover the car frame, making the setting easier.
4. Two running modes and four drag brake forces can be adjusted. Only one can meet the application of most car models.
5. Bulit-in car light control function.
6. Multiple protection functions: low/high voltage protection of battery, overheat protection and failsafe function.



## 3. Getting Started

Before operation, install the battery and connect the system as instructed below.

### 3.1 Transmitter Battery Installation

 Danger	• Only use specified battery (X4 AA batteries).
 Danger	• Do not open, disassemble, or attempt to repair the battery.
 Danger	• Do not crush/puncture the battery, or short the external contacts.
 Danger	• Do not expose to excessive heat or liquids.
 Danger	• Do not drop the battery or expose to strong shocks or vibrations.
 Danger	• Always store the battery in a cool, dry place.
 Danger	• Do not use the battery if damaged.

Battery Type: AA

1. Open the battery compartment cover.
2. Insert 4 fully-charged AA batteries into the compartment. Make sure it is connected with the correct polarity to avoid damage.
3. Replace battery compartment cover.

Low Battery Voltage Alarm: When the voltage battery is lower than 4.2V, the G.LED on the transmitter panel will flash slowly.

### 3.2 Receiver and Servo Installation

Make sure that the receiver is mounted in an appropriate location within the model, to ensure a stable signal, maximum range and to mitigate external interference, follow these guidelines:

Pay attention to the following when installing the receiver:

1. Make sure the receiver is not installed near motors or sources of electrical noise.
2. Keep the receiver's antenna away from conductive materials such as carbon or metal. To ensure normal function, make sure there is a gap of at least 1cm between the antenna and the conductive material.

 Caution	• To prevent damage do not power on the receiver during installation.
---	---



微信公众号



Bilibili



Website



Facebook





## 4. Instructions

After setting up, follow the instructions below to operate the system.

### 4.1 Power On

Follow the steps below to turn on the transmitter:

1. Check to make sure that that battery is fully-charged and installed correctly.
2. Toggle the switch to the [ON] position, and the R.LED will be solid on.
3. Power on the receiver.
  - For safety, always power on the transmitter before the receiver.

 Warning	• Operate with caution in order to avoid damage or injury.
 Warning	• Make sure that the throttle trigger is at its neutral position and the switches are set to their proper position.

### 4.2 LED Indicator

1. R.LED: The red power indicator;
2. G.LED: The green status indicator;
3. Car Battery: ESC battery power indicator
  - When the power is high, the Car Battery LED will be solid on in green.
  - When the power is medium, the Car Battery LED will be solid on in yellow.
  - When the power is low, the Car Battery LED will be solid on in red.
  - When the power is ultra low, the Car Battery LED will be flash slow in red.
  - When the receiver is not connected, the Car Battery LED will maintain the last indicated state.

### 4.3 Binding

The transmitter and receiver have already been bound at the factory.

However if the receiver needs to be replaced or additional receivers bound follow these steps:

1. Turn on the transmitter while holding the BIND button, then the transmitter will enter the bind mode. At this time, the G.LED will start flashing quickly. Once in bind mode, release the BIND button.
2. Turn on the receiver, and it will wait for 1 second for connection. If without connection, the receiver will enter the binding mode automatically.
3. Once the binding is successful, the receiver LED and the G.LED of the transmitter will be solid on.

Note: In case of binding, put the transmitter into bind mode first, then the receiver. If the binding is not completed within ten seconds, the LED of the receiver will enter its slow flashing state.

- |   |
|---|
| • <b>Applicable to FS-G4P1-BS transmitter and FS-R4D-ESC-BS receiver. Different receivers have different bind procedures. For more information, visit the FLYSKY website for manuals and other related information.</b> |
| • <b>Product information is updated regularly, please visit our website for more information.</b>   |



## 4.4 Stick Calibration

This function is used to set the neutral position for throttle trigger and steering wheel.

Every transmitter is calibrated before leaving the factory, however if recalibration is required, please follow these steps:

1. Turn and hold the steering wheel clockwise to the max travel point and push the throttle trigger forwards as far as possible, and at the same time turn on the transmitter, the transmitter will be in calibration mode.
  - The R.LED and G.LED will work in two-flash-one-off mode.
  - The Car Battery LED will be solid on in yellow.
2. Calibrate steering wheel: Turn the steering wheel to max and min travel end point in clockwise and counterclockwise.
  - The R.LED will be off.
  - The Car Battery LED will be solid on in red
3. Throttle trigger calibration: Push/pull the throttle trigger to forward/backward as far as it will go.
  - The G.LED will be off.
  - The Car Battery LED will be solid on in green.
4. Both the steering wheel and the throttle trigger have been finished the calibration.
  - The Car Battery LED will be off.
5. Once the calibration is finished, press the BIND button to save and exit.

## 4.5 Power Off

Follow the steps below to turn off the system:

1. Turn off the receiver.
2. Toggle the transmitter's power switch to the [OFF] position.



**Danger**

- **Make sure to power off the receiver before turning off the transmitter. Failure to do so may lead to damage or serious injury.**



微信公众号



Bilibili



Website



Facebook

## 5. System Functions

This section focuses on the functions and how to use them.

### 5.1 Channel Descriptions

The transmitter outputs a total of 4 channels, which are assigned as follows, as well as the functions.

- CH1 Channel: The assigned control is the steering wheel. CH1 controls the steering to enable a car to turn left or right.
- CH2 Channel: The control is the throttle trigger, CH2 controls the throttle to enable a car to move forward or backward.
- CH3 Channel: The control is the CH3 three-position switch. Users can customize the channel function. For example, function as a fast or slow servo channel, or to control car lights.
- CH4 Channel: The control is the CH4 button switch. Users can customize the channel function. For example, control car lights and control the car light switching mode.

Note: By default the output of CH4 is 1000us, after which pressing the button will toggle between 1000 and 2000us.

### 5.2 Channel Reverse

This function is used to adjust action direction of the servo or motor.

The ST.REV / TH.REV switches are the reverse buttons for CH1 and CH2. If the switch is up, it indicates reverse, and the down indicates normal.

### 5.3 Trims

The ST.TRIM switch is used to adjust the trim for CH1 (steering), and can also adjust the trims for CH3 and CH4 as multiplexing mode. For multiplexing switching mode, see [5.5 Mode Switching].

The TH.TRIM switch is the trim for CH2(throttle).

Adjustment range: -120us ~ + 120us, each step is 4us;

ST.TRIM + / TH.TRIM + : Increase the trim value.

ST.TRIM- / TH.TRIM-: Decrease the trim value.

LED status in case of adjusting trims:

- When using the trim switches, the G.LED will flash slowly on short presses and quickly on long presses.
- When the trim value reaches 0 (Centered), the G.LED will flash twice slowly.
- When the trim value reaches both ends (+ 120us / -120us), the trim adjustment is at its maximum/minimum position and as such case, the G.LED will not flash(if the trim value has been adjusted to + 120us, then press ST.TRIM + / TH.TRIM + switches are invalid and the G.LED has no prompt).

Note: After the throttle trim is changed, the receiver needs to be re-powered on to recognize the new throttle neutral. Otherwise, an exception may occur during vehicle reversing.



## 5.4 D/R

The ST. D/R switch is used for servo travel adjustment, and can also adjust the D/R for CH2 (throttle), CH3 and CH4 servo travel adjustment as multiplexing mode, see [5.5 Mode Switch] for multiplex switching mode;

Adjustment range: 0-120%(the default is 100%), the step is 5%.

ST.D / R +: Increase servo travel amount.

ST.D / R -: Decrease servo travel amount.

LED status in case of adjusting D/R:

- When using the D/R switches, the G.LED will flash slowly on short presses and quickly on long presses.
- When the D/R value reaches both ends (0/120%), the ST.D / R switch is at its maximum/minmum position and as such case, the G.LED will not flash(if the D/R value has been adjusted to 120%, then press ST.D/R+ switch is invalid and the G.LED has no prompt)

## 5.5 Mode Switching

This function is for reusing the ST.TRIM switches and ST.D / R switch for different channels (see [5.3 Trims], [5.4 D/R]).

Setup:

Under normal power-on condition, quickly press the BIND button twice (within 1 sencond) to cycle through modes 1, 2, 3, and 4. By default, the mode 1 is used.

Mode 1: The G.LED slowly flashes once, the ST.TRIM switches are for CH1 trim adjustment, and the ST.D / R switch is for CH1 D/R adjustment.

Mode 2: The G.LED slowly flashes twice, the ST.TRIM switches are for CH1 trim adjustment, and the ST.D / R switch is for CH2 D/R adjustment.

Mode 3: The G.LED slowly flashes for three times, the ST.TRIM switches are for CH3 trim adjustment, and the ST.D / R switches are for CH3 D/R adjustment.

Mode 4: The G.LED slowly flashes for four times, the ST.TRIM switches are for CH4 trim adjustment, and the ST.D / R switch is for CH4 D/R adjustment.

## 5.6 Failsafe

The failsafe function is used to protect the model and personnel when the receiver is out-of-control.

The failsafe for CH2 is enabled by default, the ESC motor channel will enter the brake state when the receiver is out-ofcontrol. By default, the failsafe for CH1, CH3 and CH4 channels are not set, and can be set at the transmitter side, and these three channels will not output in case of out-of-control.

Setup:

In the normal power-on state, set the control corresponding to the channel to be configured with failsafe to the preset position, meanwhile, press and hold the BIND button for 3 senconds to set the output value as the failsafe value. And if the G.LED flashes for 2 seconds, it indicates that the setting is successful. Then the failsafe value set will output in case of out-of-control.



微信公众号



Bilibili



Website



Facebook

## 5.7 Beginner Mode

Beginner mode is designed for people who is new to the hobby.

In this mode, the throttle will be limited to output 50 percent, The channel range defaults to 1250~1500~1750us.

Setup:

To switch between beginner mode and normal mode, press and hold the CH4 button while turning the steering wheel completely counterclockwise as far as it can, and at the same time, power on the transmitter. When the G.LED works in two-flash-one-off mode for 3 seconds, then the beginner mode has switched. In case of the G.LED is off, the normal mode is switched.

## 5.8 ESC Parameters Setting

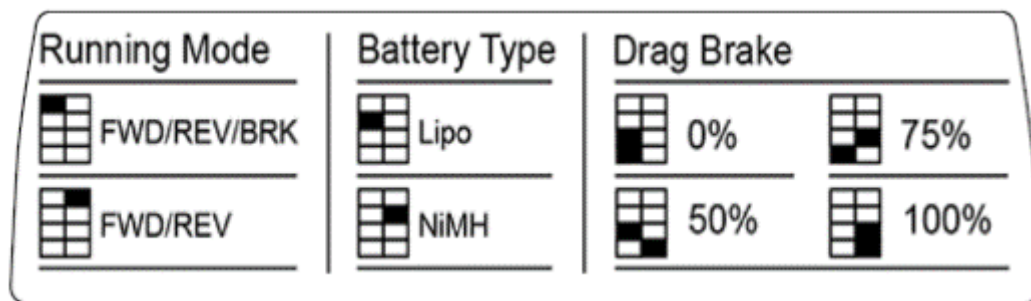

Toggle Switch Sign

The Toggle Switch on the transmitter is used to set ESC parameters, that is, the Toggle Switch is located at different positions and the corresponding parameter values are different.

There are three parameters can be set for the ESC, which are "Running Mode", "Battery Type" and "Drag Brake". There are slide switches numbered 1, 2, 3, 4 on the transmitter panel. The above parameters can be set by toggling left and right.

### Running Mode

FWD/REV/BRK(Forward/Reverse/Brake): This mode adopts "double click" reverse mode, that is, when the throttle trigger is pushed from neutral range to the reverse area for the first time, the motor is only braking and will not reverse; When the throttle trigger is moved back to the neutral range and pushed to the reverse area for the second time, it will reverse. This mode is applicable to general models.

FWD/REV(Forward/Reverse): This mode adopts "one click" reverse mode, that is, when the throttle trigger is pushed from neutral range to the reverse area, the motor immediately generates reverse action, which is generally applied to rock crawlers.

Setup:

Toggle the No. 1 slide switch to the left position, then the running mode is set to FWD / REV / BRK. Toggle the No. 1



slide switch to the right position, then the running mode is set to FWD/REV.

## Battery Type

There are LiPo and NiMH cells which can be set. It can be set according to the actual use.

Setup:

Toggle the No. 2 slide switch to the left position, then the battery type is set to Lipo. Toggle the No. 2 slide switch to the right position, then the battery type is set to NiMH.

## Drag Brake Force

The drag brake means that when the throttle trigger moves from the forward or reverse area to neutral range, it will produce certain braking force to the motor, the larger the value is, the greater the drag brake force is. Select proper drag brake force according to the actual situation.

Setup:

Toggle both the No. 3 and the No.4 slide switches to the left position, then the drag brake force is set to 0%. And toggle the No. 3 slide switch to the left position and the No.4 slide switch to the right position, then the drag brake force is set to 50%. Toggle the No. 3 slide switch to the right position and the No.4 slide switch to the left position, then the drag brake force is set to 75%. Toggle both the No. 3 and the No.4 slide switches to the right position, then the drag brake force is set to 100%.

## 5.9 Reset Data

To reset the function data.

Setup:

Press and hold the BIND button and CH4 button while powering on the transmitter, to reset the function data. The G.LED will slowly flash twice for prompt when the data have been reset successfully.

Note: The failsafe setting and binding information will not be reset.



微信公众号



Bilibili



Website



Facebook

## 6. FS-R4D-ESC-BS Function Instructions

This chapter mainly introduces the precautions for using the FS-R4D-ESC-BS 2-in-1 receiver and the settings of the related function.

### 6.1 Attentions

- Make sure the product is installed and calibrated correctly, failure to do so may result in serious injury.
- Please carefully check each power device and car frame instructions to ensure the power matching is reasonable before use. Avoid damaging power system due to incorrect matching.
- Do not let the external temperature of the system exceed 90°C /194 °F , because high temperature will damage the power system.
- Make sure the receiver's battery is disconnected before turning off the transmitter, failure to do so can result out of control. Unreasonable setting of the Failsafe may cause accidents.
- After use, remember to disconnect the battery and the ESC. If the battery isn't disconnected, the ESC will consume electric energy all the time even if it is off. It will discharge completely if connect the battery for a long time, thus resulting in the failure of the battery or the ESC. We are not responsible for any damage caused by this!
- Make sure the receiver is mounted away from motors or any device that emits excessive electrical noise.
- Keep the receiver's antenna at least 1cm away from conductive materials such as carbon or metal.
- Do not power on the receiver during the setup process to prevent loss of control.
- If the throttle trim is changed on the transmitter side, the receiver needs to be re-powered to recognize the new throttle neutral. Otherwise, an exception may occur during vehicle reversing.

### 6.2 Binding Instruction

If it needs to rebind the receiver and the transmitter, refer to 4.3 Binding for details.

### 6.3 Protect Function

This receiver has low/high voltage protection function.

**Low Voltage Protection:** The receiver will enter the low voltage protection state in case of detecting low voltage, CH2 motor channel has no output. Channels of CH1, CH3 and CH4 output normally, and all the lights flash slowly for prompt.

**High Voltage Protection:** When the receiver enters the high voltage protection state, all channels have no output. All car lights quickly flash for prompt.

**Note:** The ESC LED flashes slowly and continuously; When the voltage is normal, then the receiver will exit the protection state.



The receiver supports the overheating protection function.

Overheating protection: When the receiver enters the overheating protection state in case of the high internal temperature of the ESC, CH2 motor channel has no output. The others output normally, and all the car lights flash fast for prompt. The CH2 motor channel will output normally when the temperature is back to normal.

## 6.4 Car Light Control

The control of car lights is mainly set at the transmitter side to control of car lights state and mode.

### Control Mode of the Car Lights

The car light control features four-channel control mode and two-channel control mode. By default, it is four-channel control mode.

Switching between the two control modes can be implemented by turning on the transmitter and turning the steering wheel clockwise to the maximum travel point, and turning on the power supply of the receiver at the same time.

### Four Modes/States of Car Light Operation And How to Turn On/Off It.

#### In Case of Four-channel Control Mode

Switch Method: Quickly press the CH4 button twice to switch the modes. It can switch cyclically, by default, it is the Sport mode.

Note: In the following contents, ① stands for turning lights(involved left turn signal light and right turn signal light), ② stands for Illumination/width(involved headlights and tail light), ③ stands for backward/brake(involved tail light), ④ stands for emergency lights(involved left turn signal light and right turn signal light), ⑤ stands for ambient light and roof light, and ⑥ stands for forward(involved headlight)

- **Normal Mode:** For ① : Turn the steering wheel counterclockwise, left turn signal light flashes slowly; Turn the steering wheel clockwise, right turn signal light flashes slowly. For ② : Toggle the CH3 three-position switch to the far right, the headlights are solid on and the tail light enters into its low-luminance state; Toggle it to the far left to turn off the lights. For ③ : Push the throttle trigger forward, then the tail light is solid on. For ④ : Press the CH4 button, the emergency lights flash slowly. And press it again to turn off them. For ⑤ : **Refer to Working Modes of Ambient Light And Roof Light.**
- **Sport Mode:** For ① , ② , ③ , ④ and ⑤ , refer to the description in Normal mode above. For ⑥ : Pull the throttle trigger backward, the headlights are solid on.
- **Slow Flash Mode:** Toggle the CH3 three-position switch to the far right, all car lights flash in cycle. Toggle it to the far left to turn off the lights.
- **Sharp Flash Mode:** Toggle the CH3 three-position switch to the far right, all car lights work in sharp flash state. Toggle it to the far left to turn off the lights.



微信公众号



Bilibili



Website



Facebook



## In Case of Two-channel Control Mode

Switch Method: Same as the four-channel control mode.

- **Normal Mode:** For ① : Turn the steering wheel counterclockwise, left turn signal light flashes slowly; Turn the steering wheel clockwise, right turn signal light flashes slowly. For ② : Quickly turn the steering wheel from neutral position counterclockwise for 2 times, the headlights are solid on and the tail light enters into its low-luminance state. For ③ : Push the throttle trigger forward, then the tail light is solid on. For ④ : Quickly turn the steering wheel from neutral position clockwise for 2 times, the emergency lights flash slowly. For ⑤ : **Refer to Working Modes of Ambient Light And Roof Light.**
- **Sport Mode:** For ① , ② , ③ , ④ and ⑤ , refer to the description in Normal mode above. For ⑥ : Pull the throttle trigger backward, the headlights are solid on.
- **Slow Flash Mode:** Quickly turn the steering wheel from neutral position counterclockwise for 2 times, all car lights flash in cycle.
- **Sharp Flash Mode:** Quickly turn the steering wheel from neutral position counterclockwise for 2 times, all car lights work in sharp flash state.

Note: In case of Two-channel control mode, The ② , ④ , and ⑥ off operations are the same as the trigger operations.

## Working Modes of Ambient Light And Roof Light

Ambient light and roof light include two working modes: Singleness mode and Combination mode. Switch the mode by turning the steering wheel from neutral position clockwise quickly for 4 times. It can switch cyclically, by default, it is Singleness mode.

It can be adjusted and used in Normal mode and Sports mode, but can not be used in Gradual mode and Sharp flash mode; In the Singleness mode, the ambient light and the roof light are independently controlled and do not interfere with each other; In the Combination mode, the ambient light and the roof light work together and can be controlled uniformly.

- The Combination mode includes three working modes: Fast flash, Slow flash and OFF.  
Quickly turn the steering wheel from neutral position clockwise for 3 times to switch the mode. It can switch cyclically, by default, it is OFF. In **Fast flash** mode, the ambient light and the roof light will light on in turn. In case of **Slow flash** mode, ambient light and roof light will be in gradual mode in turn.
- Under Singleness mode, the ambient light has four working modes: Gradual, Sharp flash, Three-flash-one-off and OFF.  
Quickly turn the steering wheel from neutral position clockwise for 3 times to switch the mode. It can switch cyclically, by default, it is OFF.  
The roof light has three working modes: Solid on, Slow flash and OFF.  
Quickly turn the steering wheel from neutral position counterclockwise for 3 times to switch the mode. It can switch cyclically, by default, it is Solid on mode.

Notes:

1. If the left turn signal light and right turn signal light are contrary to the actual control, it is only necessary to exchange the left and right turn signal light wires at the car light interfaces.



2. The steering CH1 channel and throttle CH2 channel for car light control are capable of automatic neutral position identifying, after the trim is turned, the receiver should be powered again to recognize the neutral positions of these two channels automatically.
3. The no-load output voltage of the car light interface is 6V, and the internal 100  $\Omega$  protection resistor has been connected in series. If an interface needs to connect multiple LEDs in parallel, it is recommended to connect a Resistor Voltage Divider in series for each LED.
4. All settings are saved when the receiver is turned off.

## 6.5 ESC Function Instructions

### Connect Related Equipment

Make sure the receiver is off before connection. Connect the motor to motor cable "+" and "-" interfaces of the receiver. Connect the servo to the 3Pin interface ("-", "+", and "S" are connected correspondingly). Connect the battery to the power cable interfaces of the receiver correspondingly.

### Calibrate the Throttle Neutral Position

1. After connecting related equipment as above, turn on the transmitter first, move the throttle trigger to the neutral position. After the calibration is successful, the ESC LED makes a long flash once and the motor gives a long beep for prompt. If the calibration has failed, the ESC LED quickly flashes continuously and at the same time the motor gives continuous fast beep for prompt. And the motor has no output.
2. Turn on the receiver. If the battery of ESC is 2S LiPo, the ESC LED quickly flashes twice (three times for 3S Lipo), and the motor gives fast twice beeps(three times for 3S Lipo); If the battery of ESC is NiMH cells, then the ESC LED flashes quickly once, and the motor gives a fast beep.

Notes:

1. The ESC can be run after completing self-inspection (about 3 seconds) if power on, otherwise it cannot be operated normally.
2. If there is no power output and the red LED of ESC flashes quickly after power on, it means that the actual throttle trigger of the transmitter is not at the neutral position, move the throttle trigger to the neutral position until the red LED of ESC does not flash.
3. If the rotation direction is not correct during running, exchange the two wires connecting the motor and the receiver.
4. To make sure everything is ok, please turn on the transmitter first and then the receiver, turn off the receiver first and then the transmitter.

### Description of LED Status During Normal Operation

- The ESC LED is off when the throttle trigger is at the neutral position without any operation, and the motor has no output.
- The ESC LED quickly flashes when the vehicle moves forward, and is solid on when the trigger is at the end position of forward/brake(100% or -100% throttle).
- The ESC LED quickly flashes when reversing or in failsafe state.



微信公众号



Bilibili



Website



Facebook

## 6.6 ESC Drag Brake Force

The receiver supports the function of setting drag brake force at the transmitter side. It can be set to four levels: 0, 50%, 75% or 100%. The default drag brake force is 0. Refer to [5.8 ESC Parameters Setting] for details.

## 6.7 ESC Running Mode

The receiver supports the function of setting running mode at the transmitter side. It can be set to two modes: FWD/REV/BRK(Forward/Reverse/Brake) or FWD/REV(Forward/Reverse). Refer to [5.8 ESC Parameters Setting] for details.

## 6.8 ESC Battery Type

The receiver supports the function of setting battery type at the transmitter side. It can be set to two types: LiPo or NiMH. Refer to [5.8 ESC Parameters Setting] for details.

## 6.9 Failsafe

The failsafe function is used to protect the model and personnel when the receiver is out-of-control. Refer to [5.6 Failsafe] for details.

Note: If in emergency state, emergency lights keep last state in case of out-of-control. For other modes of car light, all lights turn off in case of out-of-control.



## 6.10 Troubleshooting

Trouble(s)	Possible Causes	Solution(s)
The motor cannot start and the LEDs are not on after power on.	<ol style="list-style-type: none"> <li>1. The ESC has no working voltage.</li> <li>2. The switch of ESC or ESC itself is damaged.</li> </ol>	<ol style="list-style-type: none"> <li>1. Check whether there is any connection problem between the battery and ESC and whether there is faulty welding of the relevant plug.</li> <li>2. Return to factory for inspection and treatment.</li> </ol>
The motor cannot start and the red ESC LED flashes quickly after power on.	The neutral of throttle channel of transmitter is shift or changed.	Adjust the throttle channel of the transmitter to match the existing neutral point (until the red LED does not flash).
When forward the car by the transmitter, it reverse.	<ol style="list-style-type: none"> <li>1. It may caused by the connection sequence between output line of ESC and motor line.</li> <li>2.The throttle direction of transmitter is wrongly set.</li> </ol>	<ol style="list-style-type: none"> <li>1. Exchange the position of two lines of motor.</li> <li>2. Set throttle direction of transmitter to the opposite direction.</li> </ol>
The motor suddenly stops rotating during rotation.	<ol style="list-style-type: none"> <li>1.The throttle signal is lost.</li> <li>2.The ESC enters low/high voltage protection or overheat protection of battery.</li> </ol>	<ol style="list-style-type: none"> <li>1. Check the transmitter and the receiver.</li> <li>2. The red ESC LED will flash in a single cycle. Please check the battery voltage and the temperature of the ESC.</li> </ol>
When the motor starts, it accelerates rapidly, and the motor is stuck or stops.	<ol style="list-style-type: none"> <li>1. Battery discharge capacity is insufficient</li> <li>2. The rotation speed of motor is too fast, the gear ratio is not reasonable.</li> </ol>	<ol style="list-style-type: none"> <li>1. Replace battery with strong discharge capacity.</li> <li>2. Replace low speed motor,or increase the reduction ratio.</li> </ol>



微信公众号



Bilibili



Website



Facebook

## 7. Product Specifications

This section contains FS-G4P1-BS transmitter and FS-R4D-ESC-BS receiver specifications.

### 7.1 Transmitter Specifications( FS-G4P1-BS)

Product Model	FS-G4P1-BS
Compatible Receivers	FS-R4D-ESC-BS, FS-R4A3-BS
Channels	4
Model Type	Car, Boat
RF	2.4GHz ISM
Maximum Power	< 20dBm (e.i.r.p.) (EU)
2.4GHz Protocol	2A-BS
Distance	>150m (ground distance without Interference)
Channel Resolution	4096
Battery	6V/DC or 1.5AA*4
Charging Interface	None
Low Voltage Alarm	<4.2V
Antenna Type	Single Built-in Antenna
Data Interface	None
Temperature Range	-10°C ~ +60°C
Humidity Range	20% ~ 95%
Online Update	None
Dimensions	160*193*97mm
Weight	220g
Certifications	CE, FCC ID: N4ZG4P00



## 7.2 Receiver Specifications (FS-R4D-ESC-BS)

Product Model	FS-R4D-ESC-BS
Compatible Transmitters	FS-G4P1-BS, FS-MG41-BS
Applicable Motors	540, 390, 370 or 280 Brushed Motor
Main Applications	1:10 Crawler Car, Short-course Truck or Truck
LiPo/NiMH Cells	2-3 LiPos or 5-7 NiMH cells
Continuous / Peak Current	40A/200A
Parameter Setting	Transmitter
Number of Channels	4
Number of Light Interfaces	6
RF	2.4GHz ISM
2.4GHz Protocol	2A-BS
BEC Output	6V/3A
Maximum Power	< 20dBm (e.i.r.p.) (EU)
Distance	>150m (ground distance without Interference)
Antenna Type	Single External Antenna
Channel Resolution	4096
Data Interface	PWM
Temperature Range	-10°C ~ +60°C
Humidity Range	20% ~ 95%
Online Update	None
WaterProof	PPX7
Weight	43g
Dimensions	44.0mm*30.0mm*16.7mm
Certifications	CE, FCC ID: 2A2UNR4DESC01



微信公众号



Bilibili



Website



Facebook

## 8. Package Contents

Transmitter\*1(FS-G4P1-BS)

Receiver\*1(FS-R4D-ESC-BS)



## 9. Certifications

### 9.1 DoC Declaration

Hereby, [Flysky Technology Co., Ltd.] declares that the Radio Equipment [FS-G4P1-BS&FS-R4D-ESC-BS] are in compliance with RED 2014/53/EU.

The full text of the EU DoC is available at the following internet address: [www.flyskytch.com/info\\_detail/10.html](http://www.flyskytch.com/info_detail/10.html)

### 9.2 CE Warning

The antenna(s) used for this transmitter must be installed to provide a separation distance of at least 20 cm from all persons and must not be co-located or operating in conjunction with any other transmitter. End-users and installers must be provided with antenna installation instructions and transmitter operating conditions for satisfying RF exposure compliance.

### 9.3 FCC Statement

This equipment has been tested and found to comply with the limits for a Class B digital device pursuant to part 15 of the FCC rules. These limits are designed to provide reasonable protection against harmful interference in a residential installation. This equipment generates, uses and can radiate radio frequency energy and, if not installed and used in accordance with the instructions, may cause harmful interference to radio communications. However, there is no guarantee that interference will not occur in a particular installation. If this equipment does cause harmful interference to radio or television reception, which can be determined by turning the equipment off and on, the user is encouraged to try to correct the interference by one or more of the following measures:

- Reorient or relocate the receiving antenna.
- Increase the separation between the equipment and receiver.
- Connect the equipment into an outlet on a circuit different from that to which the receiver is connected.
- Consult the dealer or an experienced radio/TV technician for help.

To assure continued compliance, any changes or modifications not expressly approved by the party responsible for compliance could void the user's authority to operate this equipment.

This equipment complies with Part 15 of the FCC Rules. Operation is subject to the following two conditions:

- (1) This device may not cause harmful interference.
- (2) This device must accept any interference received, including interference that may cause undesired operation.

Caution!

The manufacturer is not responsible for any radio or TV interference caused by unauthorized modifications to this equipment. Such modifications could void the user authority to operate the equipment.

1. The antenna(s) used for this transmitter must be installed to provide a separation distance of at least 20 cm from all persons and must not be co-located or operating in conjunction with any other transmitter. End-users



微信公众号



Bilibili



Website



Facebook



and installers must be provided with antenna installation instructions and transmitter operating conditions for satisfying RF exposure compliance.

2. Move all your channels to the desired position.
3. Select [All channels] and then [Yes] in the confirmation box.

## 9. 4 Environmentally Friendly Disposal

Old electrical appliances must not be disposed of together with the residual waste, but have to be disposed of separately. The disposal at the communal collecting point via private persons is for free. The owner of old appliances is responsible to bring the appliances to these collecting points or to similar collection points. With this little personal effort, you contribute to recycle valuable raw materials and the treatment of toxic substances.



### CAUTION

RISK OF EXPLOSION IF BATTERY IS REPLACED BY AN INCORRECT TYPE.  
DISPOSE OF USED BATTERIES ACCORDING TO THE INSTRUCTIONS



# FLYSKY



微信公众号



Bilibili



Website



Facebook

[www.flysky-cn.com](http://www.flysky-cn.com)

Copyright ©2023 Flysky Technology Co., Ltd.

Release date: 2023-12-25



FCC ID: N4ZG4P00  
FCC ID: 2A2UNR4DESC01

Manufacturer: ShenZhen FLYSKY Technology Co., Ltd.

Address: 16F, Huafeng Building, No. 6006 Shennan Road, Futian District, Shenzhen, Guangdong, China